

SHINDENGEN

Schottky Rectifiers (SBD)

Single

DE5S4M

40V 5A

FEATURES

- SMT
- Tj150°C
- P_{RRSM} avalanche guaranteed
- High current capacity with Small Package

APPLICATION

- Switching power supply
- DC/DC converter
- Home Appliances, Office Equipment
- Telecommunication

OUTLINE DIMENSIONS

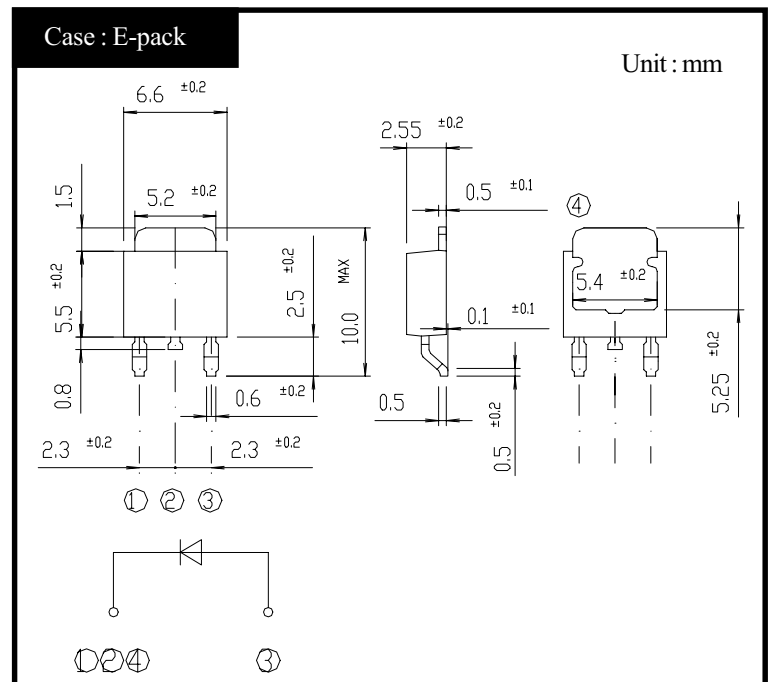

RATINGS

● Absolute Maximum Ratings (If not specified T_c=25°C)

Item	Symbol	Conditions	Ratings	Unit
Storage Temperature	T _{stg}		-40~150	°C
Operating Junction Temperature	T _j		150	°C
Maximum Reverse Voltage	V _{RM}		40	V
Repetitive Peak Surge Reverse Voltage	V _{RRSM}	Pulse width 0.5ms, duty 1/40	45	V
Average Rectified Forward Current	I _O	50Hz sine wave, R-load With heatsink T _c =101°C	5.0	A
		50Hz sine wave, R-load Without heatsink T _a =25°C	3.1	
Peak Surge Forward Current	I _{FSM}	50Hz sine wave, Non-repetitive 1 cycle peak value, T _j ≦125°C	80	A
Repetitive Peak Surge Reverse Power	P _{RRSM}	Pulse width 10 μs, T _j =25°C	330	W

● Electrical Characteristics (If not specified T_c=25°C)

Item	Symbol	Conditions	Ratings	Unit
Forward Voltage	V _F	I _F =5A, Pulse measurement	Max.0.55	V
Reverse Current	I _R	V _R =V _{RM} , Pulse measurement	Max.3.5	mA
Junction Capacitance	C _j	f=1MHz, V _R =10V	Typ.180	pF
Thermal Resistance	θ _{jc}	junction to case	Max.12	°C/W
	θ _{ja}	junction to ambient	Max.55	

DE5S4M

Forward Voltage

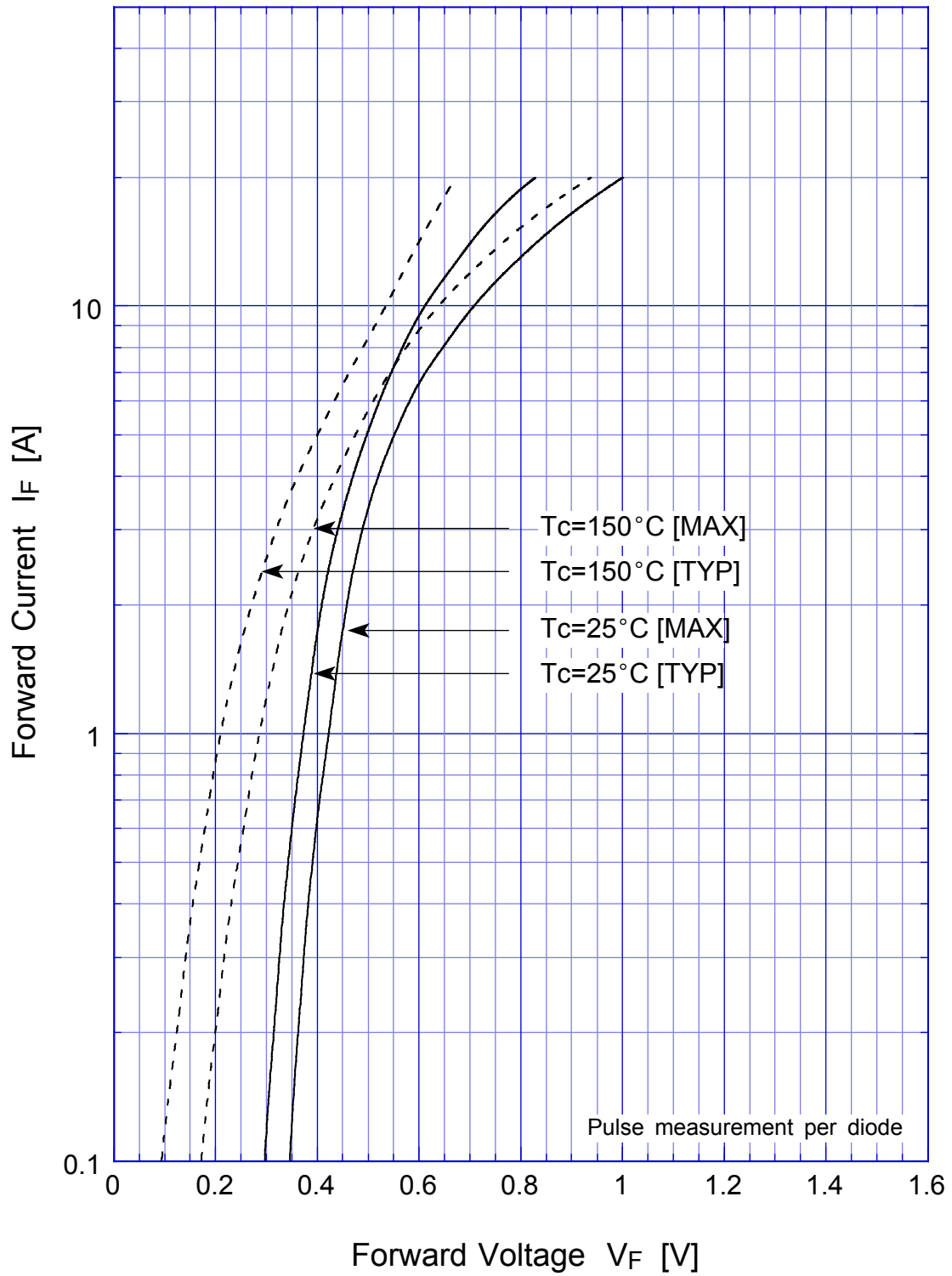

DE5S4M

Junction Capacitance

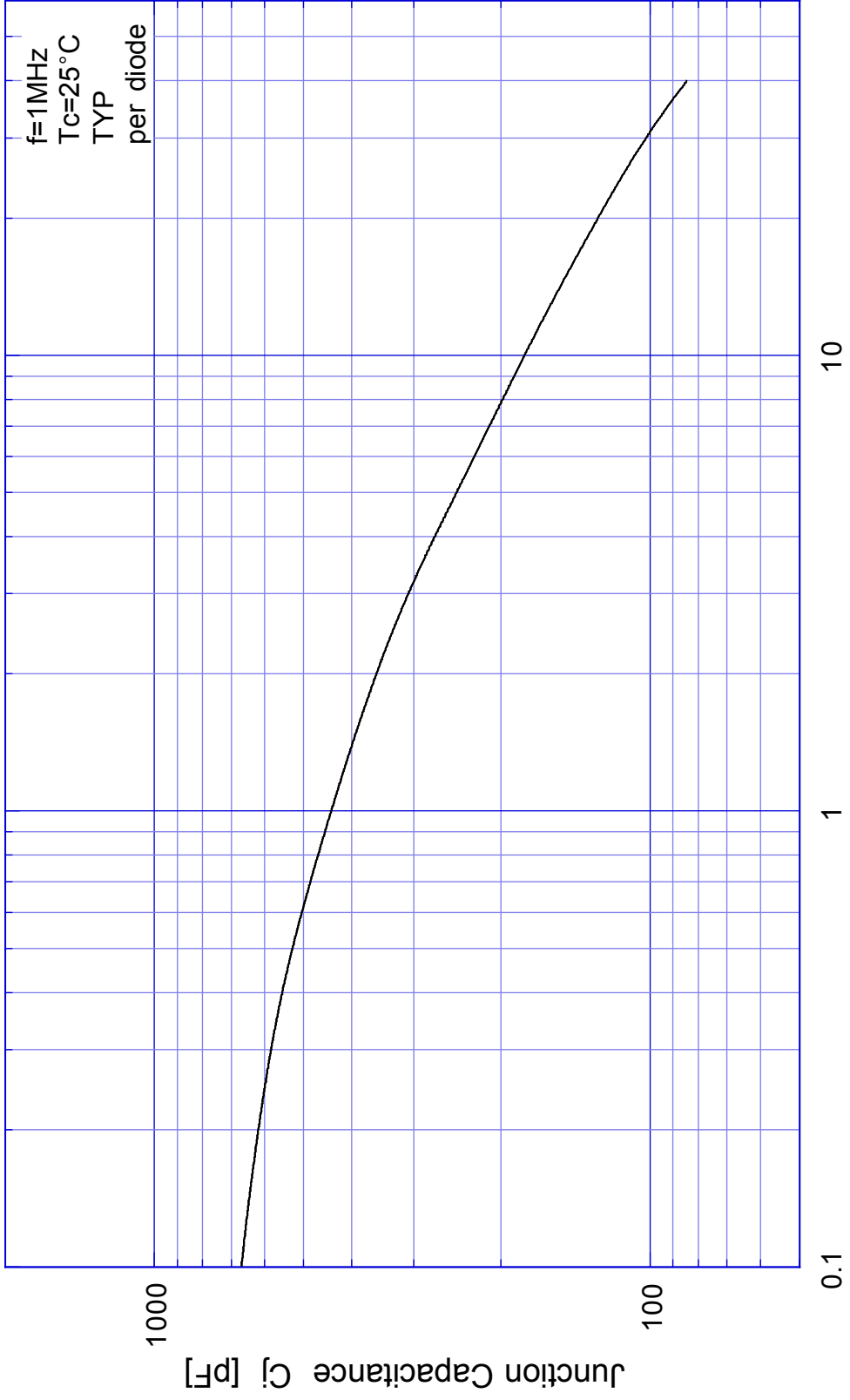

DE5S4M

Reverse Current

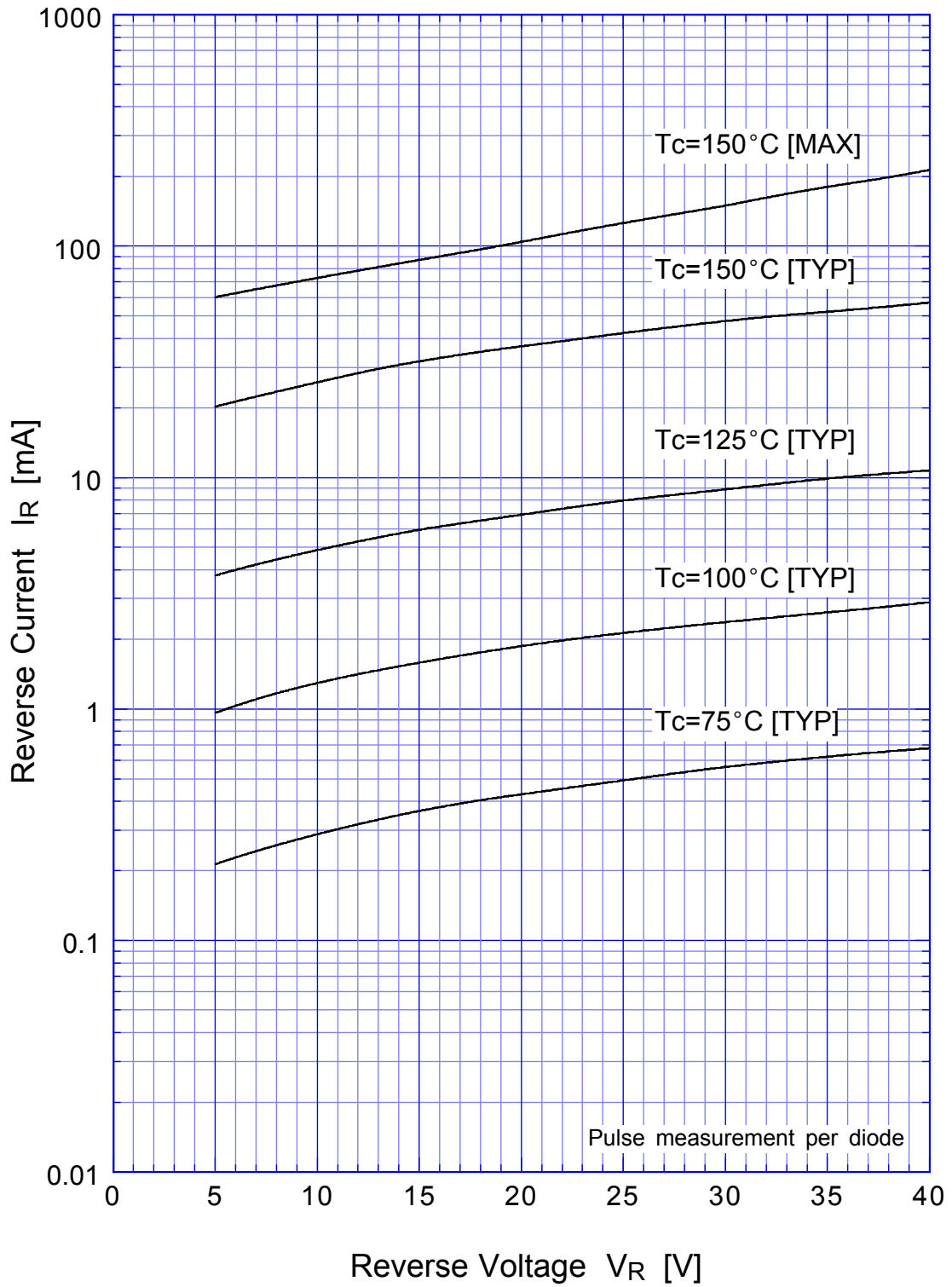

DE5S4M Reverse Power Dissipation

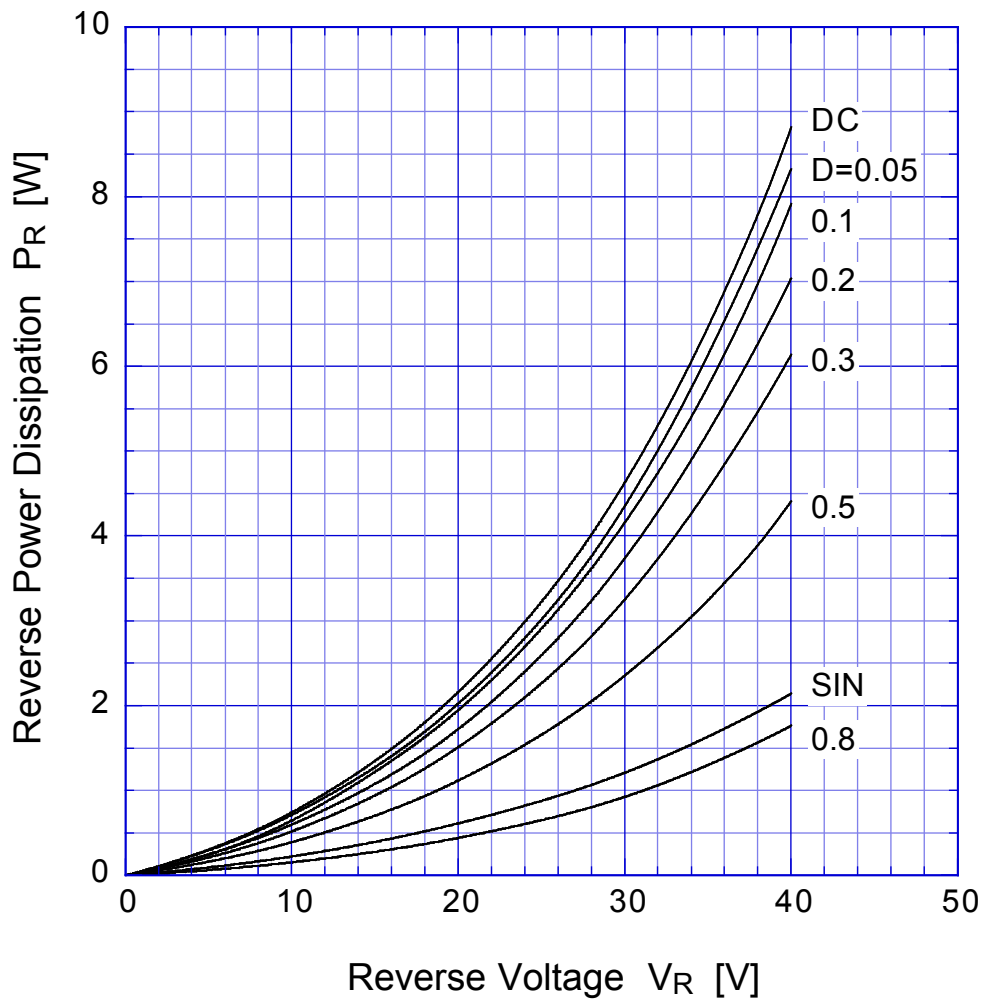

$T_j = 150^\circ\text{C}$



DE5S4M Forward Power Dissipation

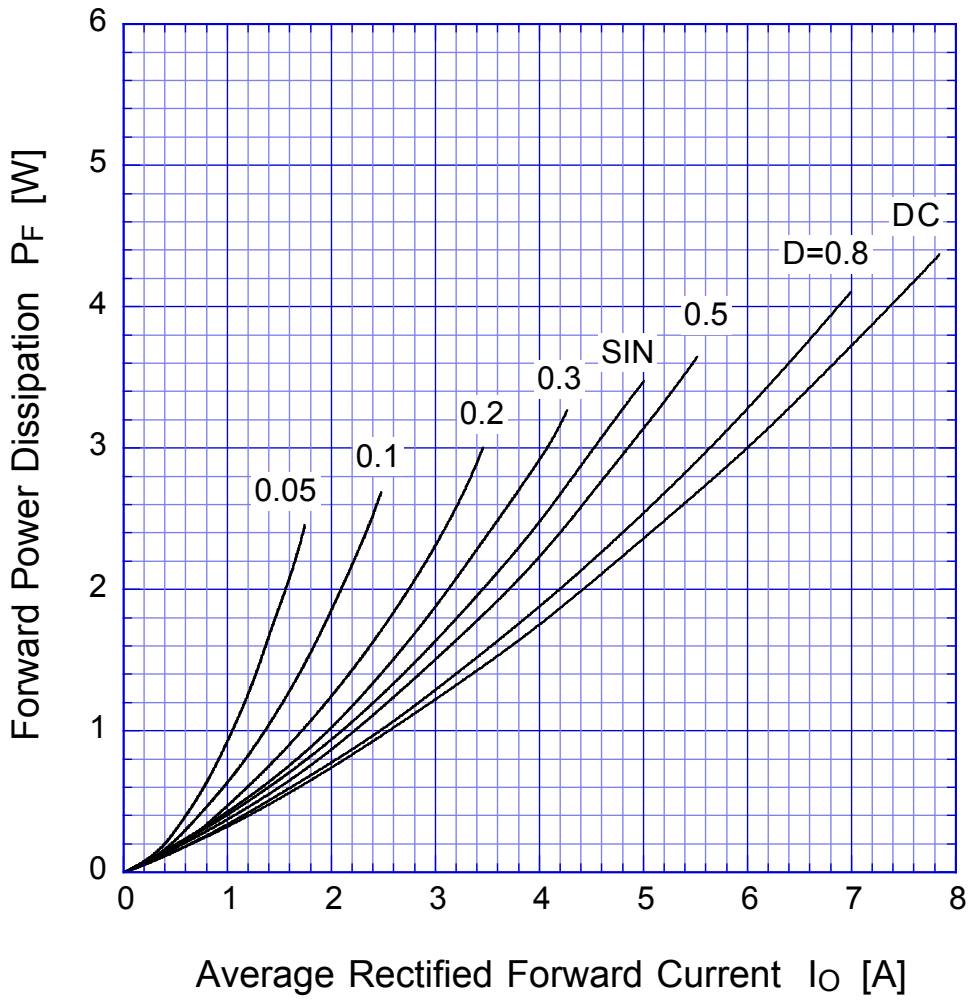

$T_j = 150^\circ\text{C}$

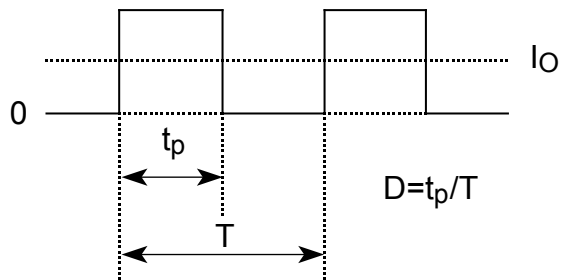

DE5S4M

Derating Curve

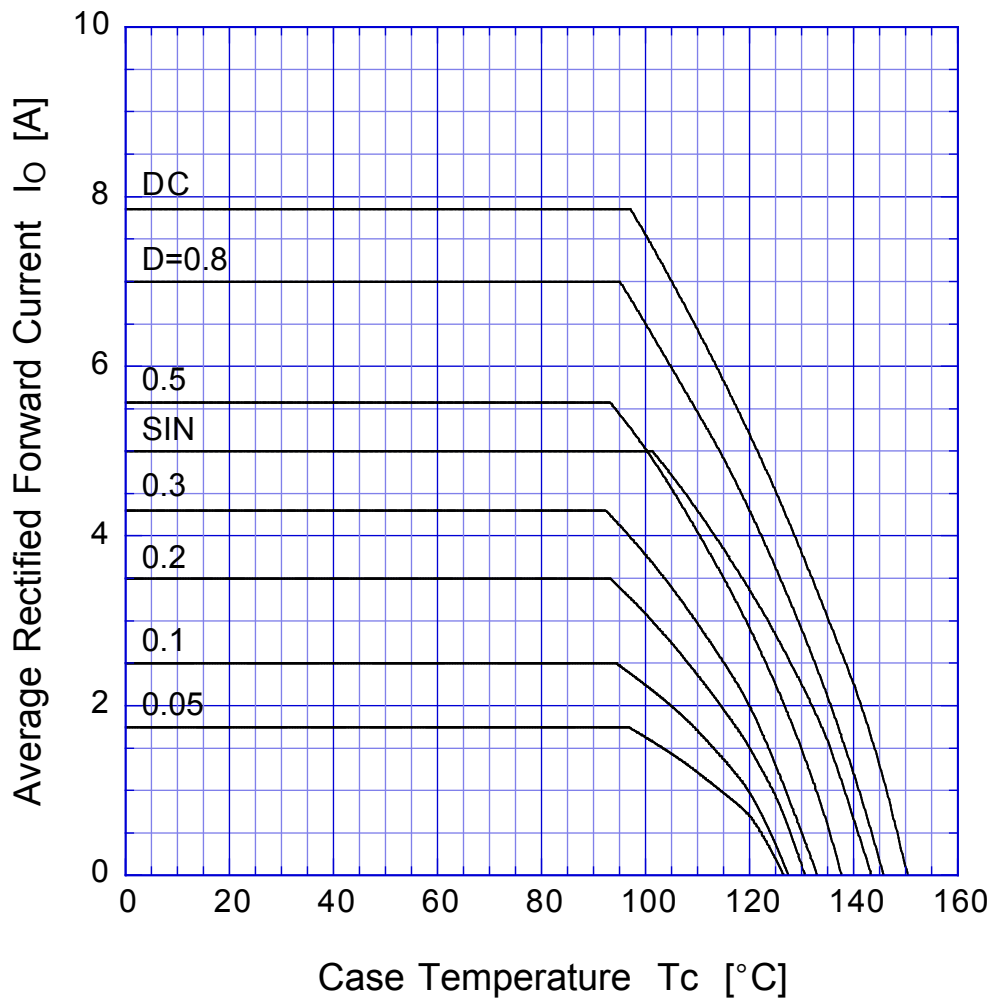

$V_R = 20V$



DE5S4M

Derating Curve

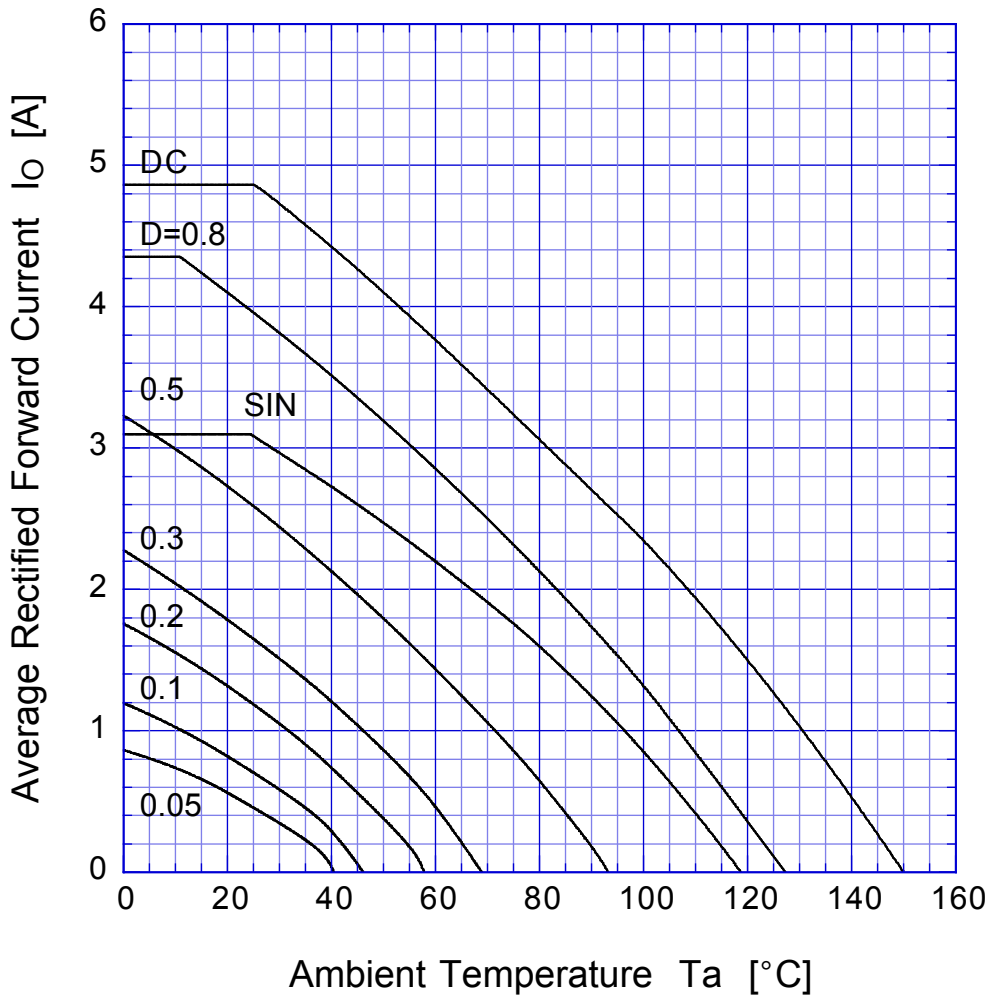

$V_R = 20V$

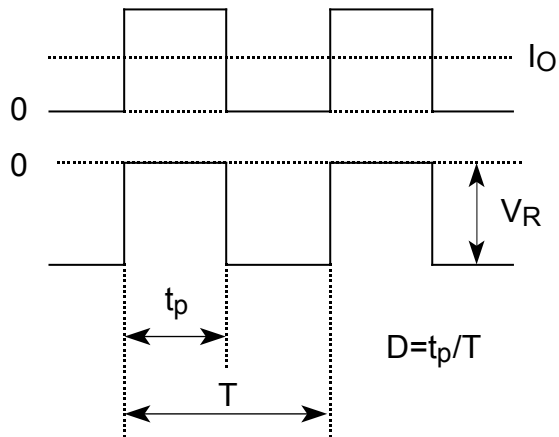

DE5S4M

Derating Curve

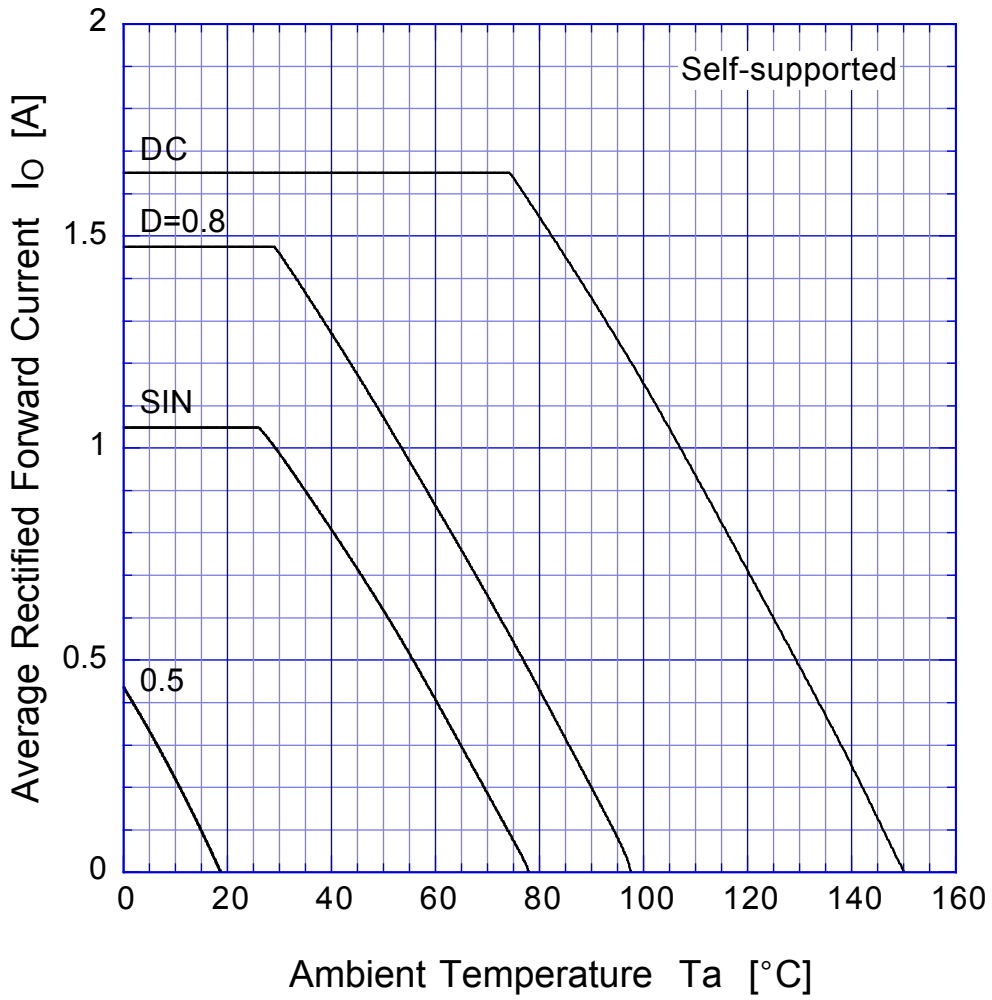

$V_R = 20V$

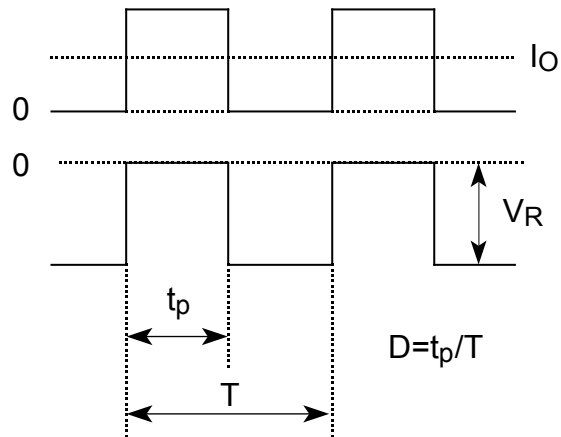

DE5S4M

Peak Surge Forward Capability

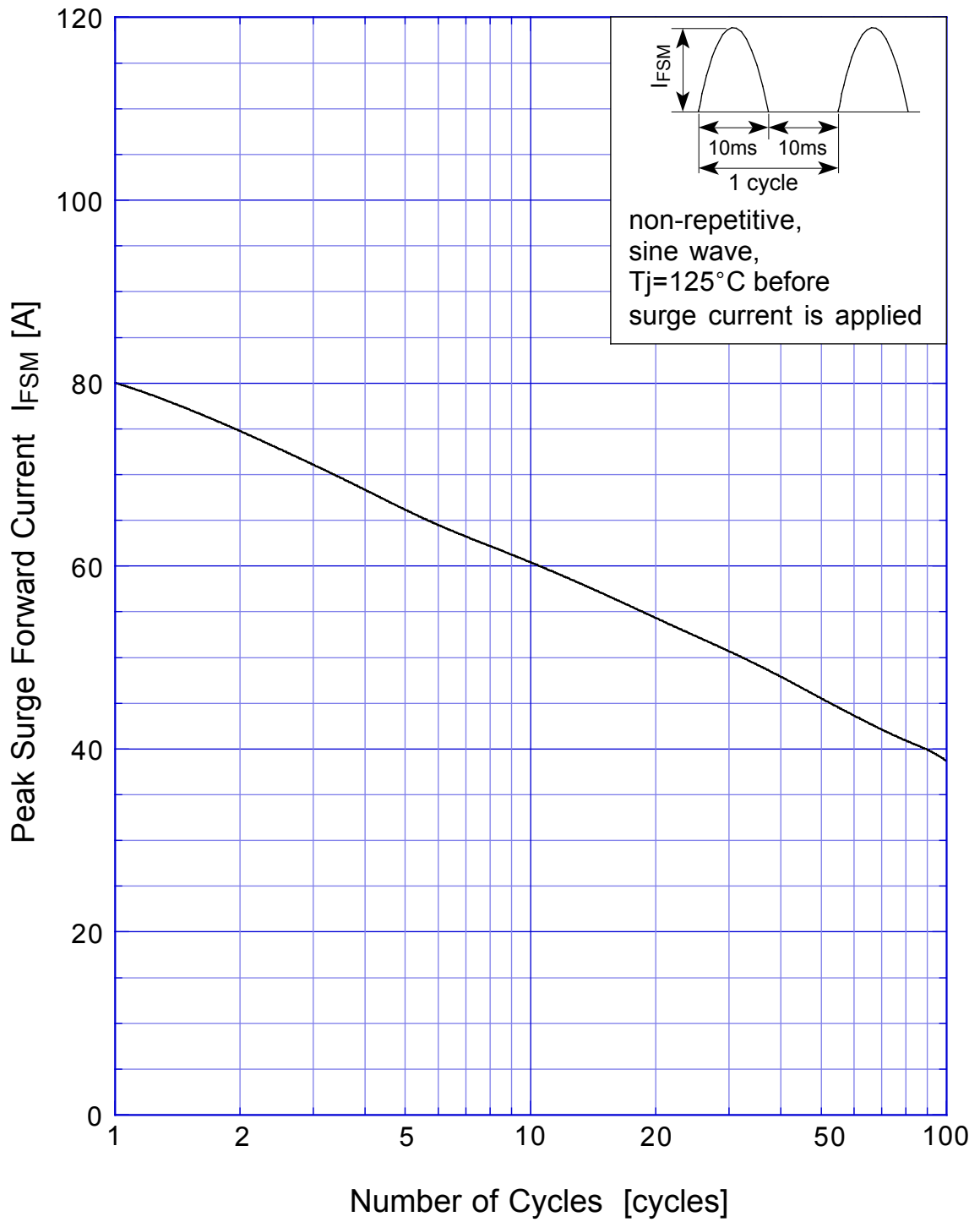

SBD Repetitive Surge Reverse Power Derating Curve

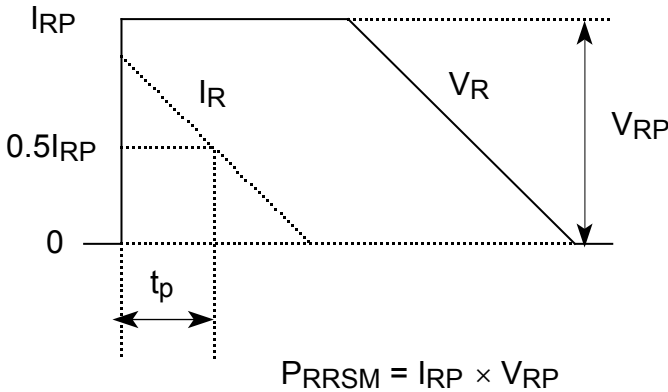
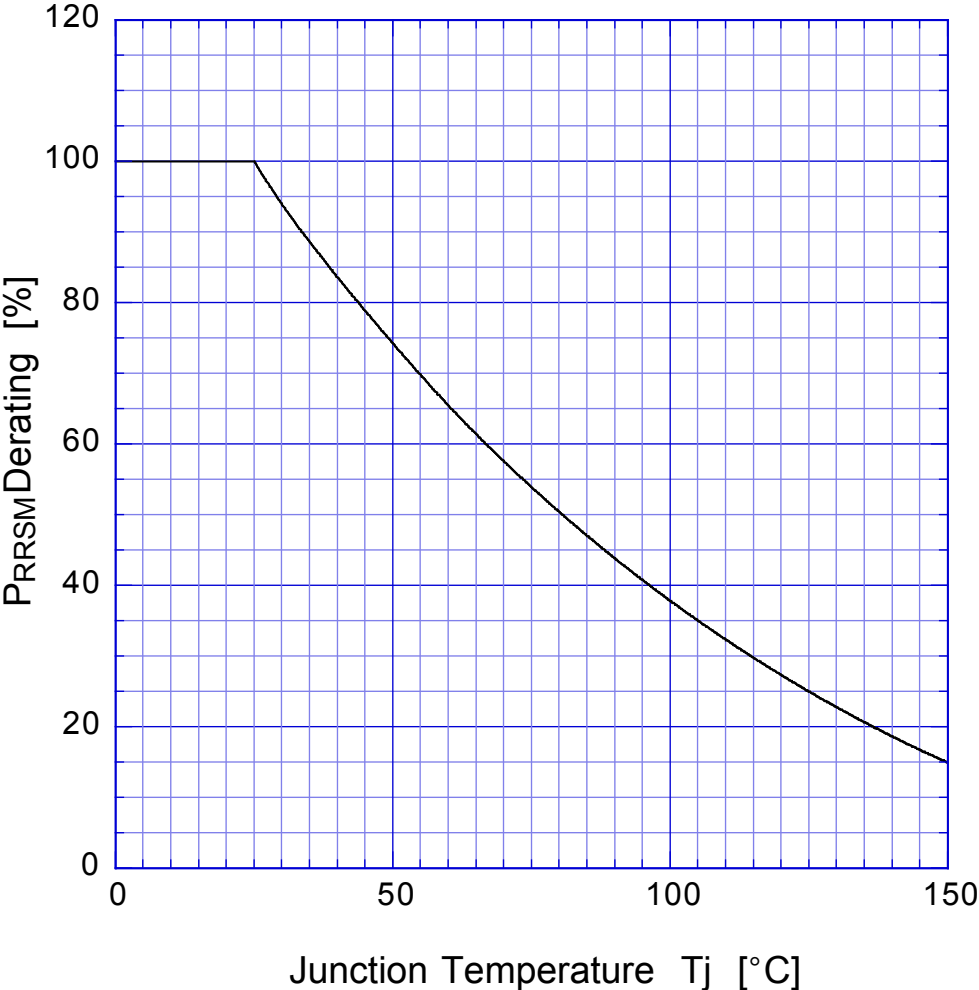

SBD

Repetitive Surge Reverse Power Capability

